

TORK®

OCCUPANCY SENSORS



APRIL 2008

A DIVISION OF **NSi** NSi INDUSTRIES, LLC

Table of Contents

OSC20UP Dual Technology/Passive Infrared (PIR) and Ultrasonic Sensor1

OSCW5P, OSCW15P Passive Infrared (PIR) Sensors . 2

OSC15PLS Passive Infrared (PIR) Sensor With Ambient Light Override 3

ULTRASONIC SERIES: OSC5U, OSC10U, OSC20U Ultrasonic Sensors4

OSWS SERIES: OSWS9P-120/-277, OSWS9PD, & OSWS9PDM Passive Infrared (PIR) In-Line Wall Switches 6

ELS-1 Electronic Light Sensor for Indoor Light Level Control8

ALPHANUMERIC INDEX

CATALOG SERIES	PAGE	CATALOG SERIES	PAGE
ESL-1	8	OSC5U, OSC10U, OSC20U	4
OSC15PLS	3	OSCW5P, OSCW15P	2
OSC20UP	1	OSWS	6

TERMS OF SALE

TORK VENDOR NUMBER: 786261

1. Prices are F.O.B. our plant.
2. Prices do not include any sales tax.
3. Freight charges will be prepaid on all orders \$250.00 and over shipping within continental USA using standard shipping methods and service.
4. Minimum order – \$100.00.
5. Claims for shortage, erroneous charges or price corrections shall be deemed waived unless made in writing, delivered to NSi within 30 days of invoice.
6. Terms of payment – 2% 10th prox. net 25th following.
7. Warranties – NSi guarantees all products to be free of defects in material and workmanship for a period of 1 year from date of sale. Any claims for defective material must be agreed to in writing by NSi. Defective material will be replaced on an F.O.B. – our factory basis. NSi disclaims the implied warranty of fitness for a particular application.

OTHER PRODUCTS AVAILABLE

NSi can provide many other products for special applications which are not listed in this catalog. If you require an item which you do not find listed, please contact us. We would be pleased to provide a quotation upon receipt of a drawing or a sample.

GUARANTEE

It is our goal to provide extraordinary products and service on a daily basis. If our products or service do not meet with your satisfaction, please let us know immediately and we promise to make every reasonable effort to remedy the situation.

OSC20UP

DUAL TECHNOLOGY PIR/ULTRASONIC SENSOR CEILING MOUNT 2000 SQUARE FT COVERAGE

TORK
OCCUPANCY
SENSORS



APPLICATIONS:

- Offices
- Small Conference Rooms
- Break Rooms

**MEETS CALIFORNIA
ENERGY COMMISSION'S
TITLE 24 REQUIREMENTS**

The OSC20UP dual technology ceiling mount occupancy sensor combines both ultrasonic (US) and passive infrared (PIR) sensing technologies to turn lighting systems on and off based on occupancy. The combination of these two technologies provides crisp turn-ONs and virtually eliminates false turn-OFFs. The OSC20UP features IntellADAPT™ technology which continually analyzes the environment and adapts to meet specific challenges. This technology eliminates manual sensitivity and timer adjustments during installation and over the life of the sensor, providing true, maintenance free operation.

FEATURES

INTELLADAPT™: Sensor automatically determines optimum setting to properly cover the area. Excellent false tripping immunity, no manual sensitivity/timer adjustments = maintenance free operation.

SPECIFICATIONS

INTELLADAPT™: Auto reset from test setting; self adjusting timer and ultrasonic thresholds, Automatic false-ON & false-OFF corrections.

LED LAMP: Red for infrared motion, Green for ultrasonic motion.

TIMER TIMEOUT: Automatic mode = 8min-32min (self-adjusts based on occupancy). Test mode = 8sec for easy check at installation.

ULTRASONIC OUTPUT: 32kHz

POWER REQUIREMENTS: 24VDC, 33mA (uses TRP-D powerpack, not included, see below).

ALL DIGITAL, ULTRASONIC/PIR SENSOR: Multi-technology sensor provides both superior minor motion detection and PIR long-range motion detection.

COVERAGE: 2000sq.ft

SIZE: 1½" h x 4½" dia., **WEIGHT:** 5 oz.

HOUSING: High impact injection molded plastic KJB ABS Cylolac (UL945VA) flame class rating with UV inhibitors.

WIRING: 6" color coded leads provided.

COLOR: Off white

MOUNTING: Ceiling, mounting base provided.

OPERATING ENVIRONMENT: Temperature: 32° to 104°F (0° to 40°C)

Humidity: 0 to 95% R.H. non-condensing. Indoor Use.

WIRING DIAGRAM

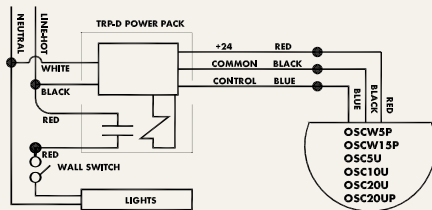

TYPICAL AREA COVERAGE

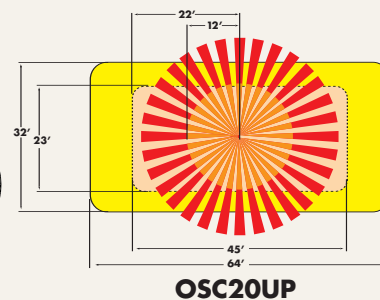

SPECIFICATIONS FOR TRP-D POWERPACKS

Multi-voltage 100 - 277 VAC 50/60 Hz input voltage 150mA, 24 VDC isolated output, short circuit protected Can supply power for up to 4 sensors.

Zero Arc Point Switching

CONTACT RATINGS: 20A, 120 VAC Incandescent,

20A, 120 or 277 VAC 20A Ballast

120 or 277 VAC 1HP Motor Load

SIZE: 3.69"L x 2.33"W x 1.36"H



**TORK TRP-D
POWER PACK
MUST BE USED IN
CONJUNCTION
WITH SENSOR.**

CATALOG NO	UPC CODE	COLOR	COVERAGE	INPUT VOLTAGE
OSC20UP	82075	WHITE	2000 SQ FT	24 VDC supplied by powerpack, below
TRP-D	82301	TRANSFORMER RELAY POWERPACK		120-277VAC

SPECIFICATION WRITER'S GUIDE

Furnish and install where indicated a Dual Technology (Ultrasonic and Passive Infrared) occupancy sensor capable of covering an area of up to 2000 sq. ft. Sensor shall be equipped with IntellAdapt™ technology which automatically determines the optimum setting to properly cover the area with no manual setting required. Sensor is to be supplied with a transformer relay powerpack which can be installed remote from sensor using low voltage wire. (Powerpack may be installed close to the load in order to minimize line voltage wiring). Sensor shall be equipped with a separate adjustment for delay time OFF of 8 minutes to 32 minutes. One transformer relay powerpack shall be capable of operation of four sensors. One sensor shall be capable of triggering 5 transformer relay powerpacks. The remote powerpack shall be capable of installation in a single or multiple gang box. Sensor and relay transformer powerpack shall be TORK OSC20UP and TRP-D respectively.

OSCW5P AND OSCW15P

PIR OCCUPANCY SENSORS CEILING AND WALL MOUNT

OSCW5P and OSCW15P Passive Infrared ceiling mount occupancy sensors use passive infrared technology to turn lighting systems on and off based on occupancy. Designed specifically for use in areas where long-range major motion detection is needed. These sensors feature IntellADAPT™ technology which continually analyzes the environment and adapts to meet specific challenges. This technology eliminates manual sensitivity and timer adjustments during installation and over the life of the product, providing true maintenance free "Install and forget" operation.



FEATURES

- IntellADAPT™ Sensor automatically determines optimum setting to properly cover the area. No manual sensitivity or timer adjustments. Excellent immunity to false tripping.
- All digital, passive infrared (PIR) sensor has superior long range detection.
- Non volatile memory ensures that learned and adjusted settings are not lost during power outages.
- 450 and 1500 ft coverage available.
- UL and ULC listed.

APPLICATIONS

- Offices
- Small Conference Rooms
- Break Rooms

SPECIFICATIONS

- IntellADAPT™: Auto reset from test setting, self adjusting timer, self adjusting passive infrared thresholds and automatic false-ON/false-OFF corrections.
- LED LAMP: red, infrared motion.
- TIMEOUT: Automatic mode 8min-32min; self adjusts based on occupancy. Test mode is 8 seconds for easy installation.
- COVERAGE: OSCW5P: 450 sq. ft.
OSCW15P: 1500 sq. ft.
- POWER REQUIREMENTS: 24VDC, 20mA (uses TRP-D power pack, not included, see below)
- OPERATING ENVIRONMENT: Indoor use only.
Operating temperature: 32° to 104°F (0° to 40°C)
Relative Humidity: 0% to 95%, non-condensing.
- CONSTRUCTION: Housing is rugged, high impact molded plastic KJB-ABS Cyclic (UL-945VA) flame class rating, UV inhibitors; 6" color coded leads.
- SIZE: 1.5" h x 4.5" dia. (38mm h x 114mm dia.)
- WEIGHT: 5.0 oz. (142g)
- COLOR: Off white
- MOUNTING: Mounting base provided with sensor.

WIRING DIAGRAM

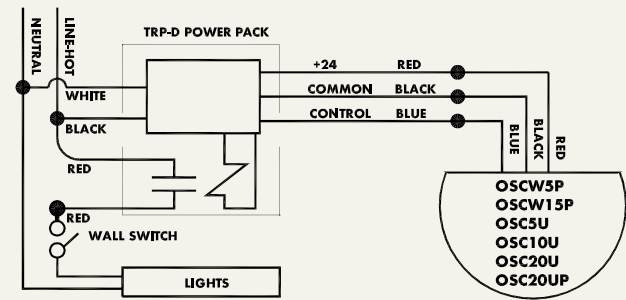

TYPICAL AREA COVERAGE

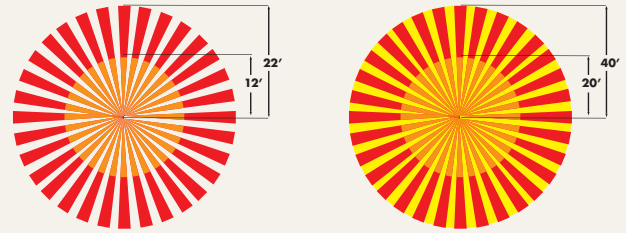

OSCW5P

OSCW15P

SPECIFICATIONS FOR TRP-D POWERPACKS

Multi-voltage 100 - 277 VAC 50/60 Hz input voltage
150mA, 24 VDC isolated output, short circuit protected
Can supply power for up to 4 sensors.
Zero Arc Point Switching
CONTACT RATINGS: 20A, 120 VAC Incandescent,
20A, 120 or 277 VAC 20A Ballast
120 or 277 VAC 1HP Motor Load
SIZE: 3.69"L x 2.33"W x 1.36"H



**TORK TRP-D
POWER PACK
MUST BE USED IN
CONJUNCTION
WITH SENSOR.**

CATALOG NO	UPC CODE	SQ FT COVERAGE	VOLTAGE
OSCW5P	82070	450	24VDC (SEE BELOW)
OSCW15P	82071	1500	24VDC (SEE BELOW)
TRP-D	82301	TRANSFORMER RELAY POWERPACK	100-277VAC

SPECIFICATION WRITER'S GUIDE

Furnish and install where indicated a passive infrared occupancy sensor capable of covering an area of up to 450 sq.ft. (OSCW5P) or 1500 sq.ft (OSCW15P). Sensor shall be equipped with IntellADAPT™ technology which automatically determines the optimum setting to properly cover the area. No manual setting is required. Sensor is to be used with a transformer relay pack (TORK model TRP-D) which can be installed remote from sensor using low voltage wire. One transformer relay powerpack shall be capable of operation of four sensors. One sensor shall be capable of triggering 5 transformer relay powerpacks. Sensor shall be equipped with a separate adjustment for delay time OFF of 8 minutes to 32 minutes. Powerpack can be installed close to the load in order to minimize line voltage wiring. Remote power pack shall be capable of installation in a single or multiple gang box.

OSC15PLS 
PIR SENSOR WITH AMBIENT LIGHT OVERRIDE
CEILING MOUNT
1500 SQUARE FT COVERAGE
WITH MULTI-VOLTAGE INTEGRAL POWERPACK

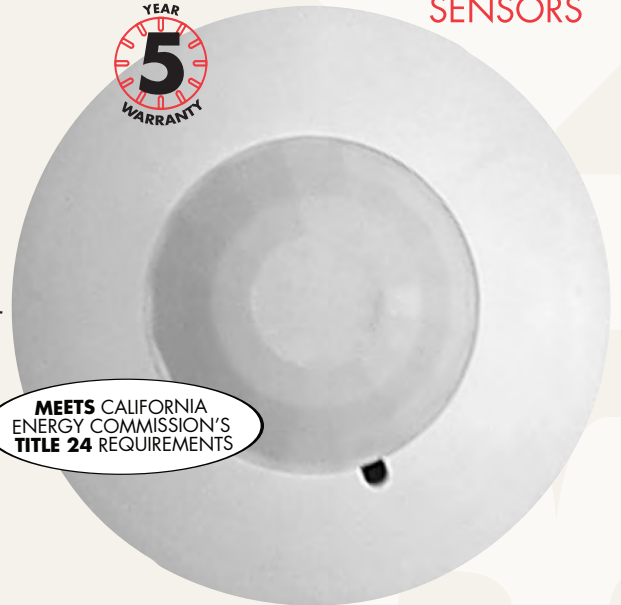

MEETS CALIFORNIA ENERGY COMMISSION'S TITLE 24 REQUIREMENTS

APPLICATIONS

- Automatically controls fluorescent and incandescent lighting with a combination of occupancy and light sensors which turn on lamps in occupied spaces only when area lighting is low (user adjustable).
- Automatically controls ventilating and exhaust fans, self-contained air conditioning units, and other motor loads based on occupancy only (user disables the light sensors).

FOR USE IN:

- Offices
- Conference Rooms
- Motels
- Classrooms
- Lavatories
- Hallways

FEATURES

- Unit contains built-in powerpack for 120-347VAC input.
- Adjustable light sensor (5 to 200 foot candles) is capable of keeping lights OFF in occupied areas when other light sources are sufficient.
- Adjustable timer for delayed turn-off in 30 seconds to 30 minutes after no movement or presence is detected.

SPECIFICATIONS

INPUT VOLTAGE: 120-347VAC, 60HZ only
VIEW ANGLE: 360°
WIRING: Line voltage wiring only between unit and load.
SIZE: 2.07" depth x 4" dia.
WEIGHT: 5 oz.
COLOR: White
MOUNTING: Ceiling
CONTACTS: SPST Dry Contacts
CONTACT RATINGS:
800 watt incandescent, 1000 watt ballast at 120VAC
1800 watt ballast at 277VAC
2200 watt ballast at 347 VAC

CATALOG NO	UPC CODE	DESCRIPTION	INPUT VOLTAGE
OSC15PLS	82076	SENSOR/POWERPACK COMBINATION	120-347VAC

WIRING DIAGRAM

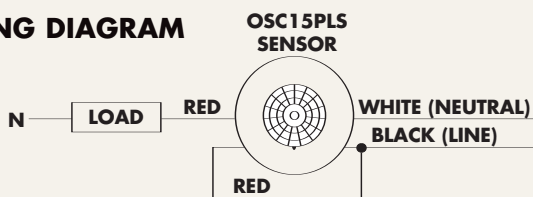

DIMENSIONS

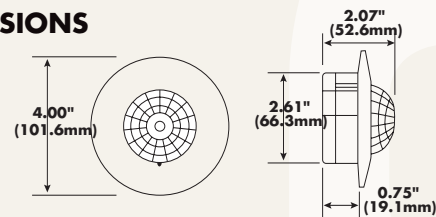

TYPICAL AREA COVERAGE

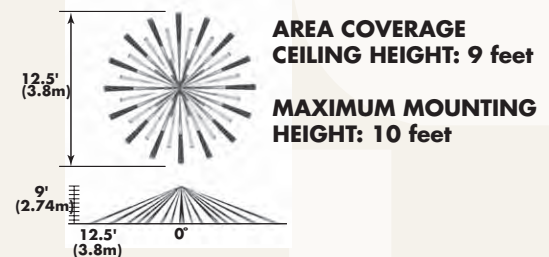

SPECIFICATION WRITER'S GUIDE

Furnish and install where indicated a passive infrared occupancy sensor capable of covering an area of up to 1500 square feet. Unit shall contain an adjustable light sensor (5 to 200 fc) capable of keeping lights OFF in occupied areas when other light sources are sufficient. Sensor shall be equipped with a separate adjustment for delayed time off of 30 seconds to 30 minutes. Sensor shall be designed for mounting onto a ceiling. Sensor shall contain a transformer relay powerpack as an integral part of the unit. Unit shall be capable of switching 120-347VAC. Unit shall be TORK Model OSC15PLS.)

ULTRASONIC SERIES

CEILING MOUNT OCCUPANCY SENSORS

FEATURING INTELLADAPT™ TECHNOLOGY



OSC5U
OSC10U
OSC20U



MEETS CALIFORNIA ENERGY COMMISSION'S TITLE 24 REQUIREMENTS

APPLICATIONS:

- Hallways
- Restrooms

FEATURES

INTELLADAPT™: Sensor automatically determines optimum setting to properly cover the area. Excellent false tripping immunity, no manual sensitivity/timer adjustments = maintenance free operation.
ALL DIGITAL, ULTRASONIC SENSOR: Superior Minor motion detection.

The OSC-U Series ceiling mount occupancy sensors use ultrasonic (US) technology to turn lighting systems on and off based on occupancy. Designed specifically for use in areas where tasks entail minor motion for long periods of time or where obstructions (such as columns, cubicles, stalls or filing cabinets) would obstruct the line of sight for an IR motion

detector. OSC-U Series sensors feature IntellADAPT™ technology which continually analyzes the environment and adapts to meet specific challenges. This technology eliminates manual sensitivity and timer adjustments during installation and over the life of the sensor, providing true, maintenance free operation.

SPECIFICATIONS

INTELLADAPT™: Auto reset from test setting; self adjusting timer and ultrasonic thresholds, Automatic false-ON & false-OFF corrections.
LED LAMP: Green for ultrasonic motion.
TIMER TIMEOUT: Automatic mode = 8min-32min (self-adjusts based on occupancy). Test mode = 8sec for easy check at installation.
ULTRASONIC OUTPUT: OSC5U = 40kHz
OSC10U/20U = 32kHz
POWER REQUIREMENTS: 24VDC, 33mA (uses TRP-D powerpack, not included, see below).

COVERAGE: OSC5U = 500sq.ft., OSC10U = 1000sq.ft.
OSC20U = 2000sq.ft
SIZE: 1½" h x 4½" dia., **WEIGHT:** 5 oz.
HOUSING: High impact injection molded plastic KJB ABS Cylolac (UL945VA) flame class rating with UV inhibitors.
WIRING: 6" color coded leads provided.
COLOR: Off white
MOUNTING: Ceiling, mounting base provided.
OPERATING ENVIRONMENT: Temperature: 32° to 104°F (0° to 40°C)
Humidity: 0 to 95% R.H. non-condensing. Indoor Use.

WIRING DIAGRAM

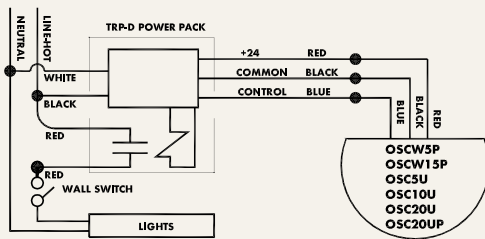

TYPICAL AREA COVERAGE

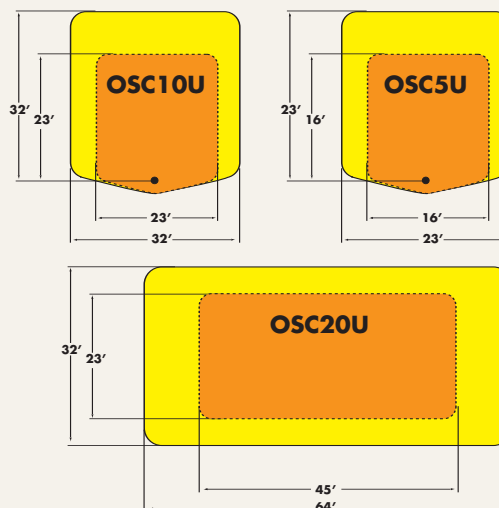

SPECIFICATIONS FOR TRP-D POWERPACKS

Multi-voltage 100 - 277 VAC 50/60 Hz input voltage
150mA, 24 VDC isolated output, short circuit protected
Can supply power for up to 4 sensors.
Zero Arc Point Switching
CONTACT RATINGS: 20A, 120 VAC Incandescent,
20A, 120 or 277 VAC 20A Ballast
120 or 277 VAC 1HP Motor Load
SIZE: 3.69"L x 2.33"W x 1.36"H

TORK TRP-D POWER PACK MUST BE USED IN CONJUNCTION WITH SENSOR.



CATALOG NO	UPC CODE	COLOR	COVERAGE	INPUT VOLTAGE
OSC5U	82072	WHITE	500 SQ FT	24 VDC supplied by powerpack, below
OSC10U	82073	WHITE	1000 SQ FT	24 VDC supplied by powerpack, below
OSC20U	82074	WHITE	2000 SQ FT	24 VDC supplied by powerpack, below
TRP-D	82301	TRANSFORMER RELAY POWERPACK		120-277VAC

SPECIFICATION WRITER'S GUIDE

Furnish and install where indicated an ultrasonic occupancy sensor capable of covering a maximum area of 500 sq. ft. (OSC5U), 1000 sq. ft. (OSC10U) or 2000 sq. ft. (OSC20U). Furnish and install a transformer relay powerpack of appropriate input voltage. Sensor shall be capable of triggering a maximum of 5 transformer relay power packs. One transformer relay power pack shall be capable of operating up to 4 sensors. Sensor shall be equipped with a sensitivity adjustment and a separate adjustment for delayed time off of 8 minutes to 32 minutes. Sensor is to be supplied with a transformer relay powerpack which can be installed remote from sensor using low voltage wire. (Powerpack may be installed close to the load in order to minimize line voltage wiring). The remote powerpack shall be capable of installation in a single or multiple gang box. Sensor shall be designed for ceiling mounting. Sensor and relay transformer powerpack shall be TORK OSC5U, OSC10U or OSC20U and TRP-D respectively.

TORK PHOTOTIMER PLUS

THE MOST FLEXIBLE PHOTOTIMER FOR MAXIMUM ENERGY SAVINGS AND ALL **ON/OFF** NEEDS!

5737TZ

The **TORK Phototimer Plus** is the most flexible photocontrol ever, operating like a photocontrol AND a time switch! Ideal for retrofit without expensive rewiring. The unit turns the load ON at sunset and can be preset to turn the load OFF up to two hours before or two hours after midnight. It can also be set to turn the load back ON from two to ten hours after midnight and OFF at dawn.

No programming is required, the microprocessor tracks dusk and dawn times and automatically determines midnight, and corrects for Daylight Savings Time. It even re-learns and resets itself after a power outage, so that no maintenance is ever needed. Ask for our TORK Photocontrol Catalog for complete details on this product and our complete range of photocontrols.



OSWS SERIES

PIR IN-LINE WALL SWITCH DECORATOR STYLE 900 SQUARE FT COVERAGE

OSWS9P-120
OSWS9P-277
OSWS9PD
OSWS9PDM



MEETS CALIFORNIA ENERGY COMMISSION'S TITLE 24 REQUIREMENTS

APPLICATIONS

Automatically controls:

- Fluorescent and Incandescent Lighting
- Ventilating and Exhaust Fans
- Self-Contained Air Conditioning Units
- Motor Loads

FOR USE IN:

- Private Office
- Small Storage Areas
- At Home
- Lavatories

COMMON FEATURES

- Replaces an ordinary toggle switch in just minutes.
- 180° view angle
- Capable of switching electronic ballasts
- Zero power switching prolongs life of relay contacts by switching high in rush equipment at or close to zero power.
- Manual OFF/auto switch
- Time delay is adjustable from 30 seconds – 30 minutes

OSWS9P-120 AND -277

- Bypass key provides permanent ON if required

OSWS9PD (DUAL VOLTAGE-120/277VAC)

- Adjustable light sensor capable of keeping lights OFF in occupied areas when ambient light is sufficient.

OSWS9PDM (DUAL VOLTAGE-120/277VAC)

- Manually activated ON feature to eliminate wasted energy due to false triggering.

SPECIFICATIONS

SWITCH CAPACITY:

OSWS9P-120: 1000 watts ballast, 800 watts incandescent, 1/2 HP at 120 VAC.

OSWS9P-277: 1800 watts ballast at 277 VAC.

OSWS9PD & OSWS9PDM: 1000 watts ballast, 800 watts incandescent, 1/2 HP at 120 VAC. 1800 watts ballast at 277 VAC.

POWER CONSUMPTION: Negligible (500 milli-watts)

SIZE (without wallplate): 1 3/4" x 2 1/8" x 1 3/8"

WEIGHT: 7 oz. • COLOR: White

For increased amperage switching, use TORK TRP-D power-pack

CATALOG NO	UPC CODE	DESCRIPTION	INPUT VOLTAGE
OSWS9P-120	82077	PIR IN-LINE WALL SWITCH	120VAC
OSWS9P-277	82078	PIR IN-LINE WALL SWITCH	277VAC
OSWS9PD	82079	PIR IN-LINE WALL SWITCH W/AMBIENT LIGHT SENSOR OVERRIDE	120/277VAC
OSWS9PDM	82080	PIR IN-LINE WALL SWITCH: MANUALLY ACTIVATED	120/277VAC

AREA COVERAGE

Top and Side Coverage Pattern Diagrams

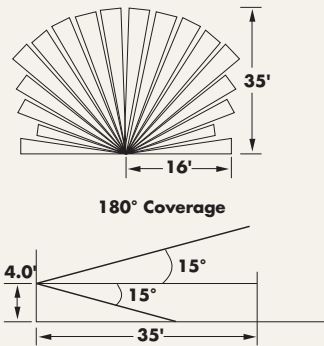

EASY INSTALLATION

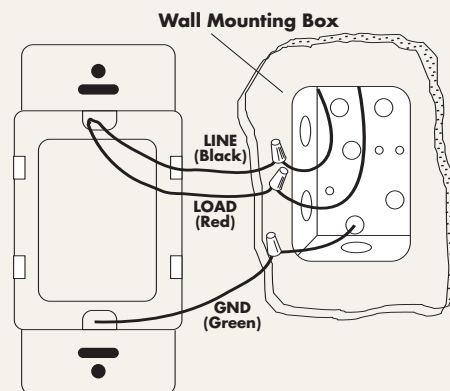

UNIT CONTROLS & ADJUSTMENTS

OSWS9P-120, -277

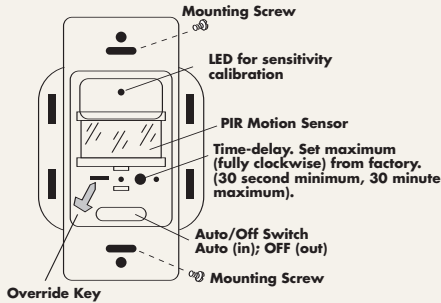

OSWS9PD

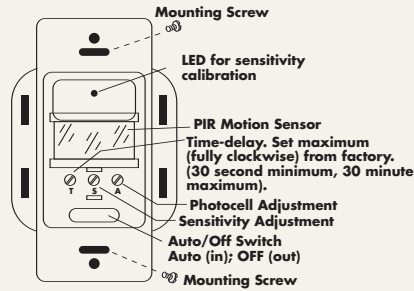

OSWS9PDM

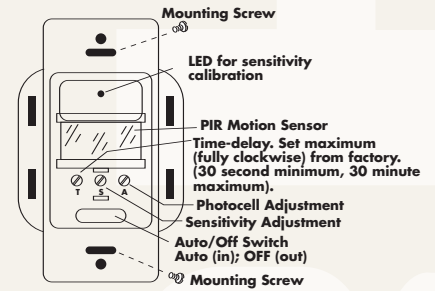

TYPICAL OCCUPANCY SENSING PATTERNS

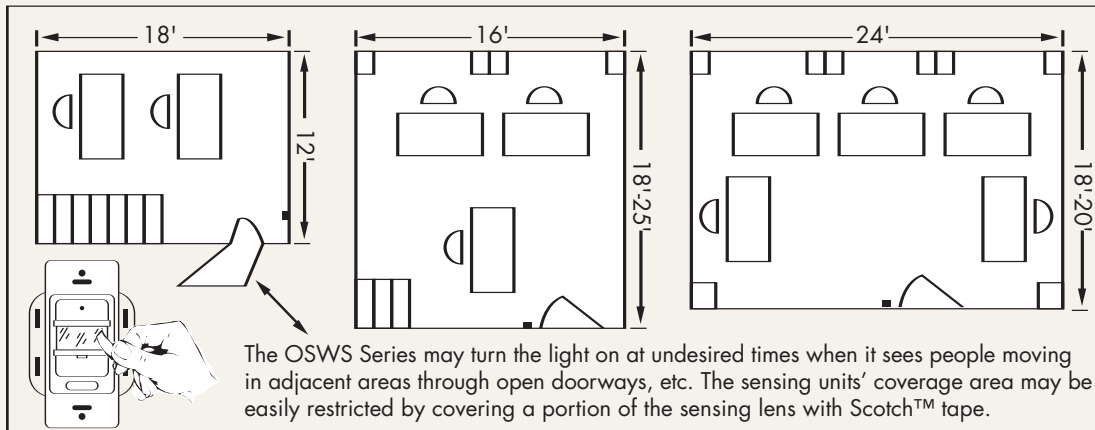

SPECIFICATION WRITER'S GUIDE

OSWS9P-120 AND -277

Furnish and install where indicated an in-line passive infrared sensor switch capable of covering up to 900 square feet, monitoring the area with a 180 degree view angle. Unit shall be capable of installation in a single or multi gang switch box with a decorator style wallplate cover. Sensor shall be designed with an adjustable time delay OFF of 30 seconds-30 minutes and shall include a manual OFF override switch and a bypass key for emergency ON. Sensor shall be TORK model number OSWS9P-120 or -277.

OSWS9PD

Furnish and install where indicated an in-line passive infrared sensor switch capable of covering up to 900 square feet, monitoring the area with a 180 degree view angle. Unit shall contain an adjustable light sensor capable of keeping lights OFF in occupied areas when other light sources are sufficient. Unit shall be capable of installation in a single or multi gang switch box with a decorator style wallplate cover. Sensor shall be designed with an adjustable time delay OFF of 30 seconds-30 minutes and shall include a manual OFF override switch. Sensor shall be TORK model OSWS9PD.

OSWS9PDM

Furnish and install where indicated an in-line passive infrared sensor switch capable of covering up to 900 square feet, monitoring the area with a 180 degree view angle. The unit shall be manually activated. Unit shall be capable of installation in a single or multi gang switch box with a decorator style wallplate cover. Sensor shall be designed with an adjustable time delay OFF of 30 seconds-30 minutes and shall include a manual OFF override switch. Sensor shall be TORK model number OSWS9PDM.

ELS-1

ELECTRONIC LIGHT SENSOR FOR INDOOR LIGHT LEVEL CONTROL

ELS-1 Electronic Light Sensor is a low profile device that assures lighting is OFF when sufficient daylight is available, saving precious energy dollars. ELS-1 should be placed about 3 feet from window or incoming daylight: when daylight level falls below the footcandle setting (user selectable), electrical lights will turn ON. When daylight level rises above the footcandle setting, electrical lights will turn OFF. A 30 second delay prevents lights from turning on due to a passing cloud, etc. Adjustable timer for delayed turn-off in 3-15 minutes, and manual override provision in the unlikely event of system failure.



MEETS CALIFORNIA ENERGY COMMISSION'S TITLE 24 REQUIREMENTS

APPLICATIONS

- Controls both Fluorescent and Incandescent Lighting Systems.

FOR USE IN:

- Office
- Conference Room
- Motel
- Drafting Room
- Corridor
- Classroom
- Lavatory
- Lobby
- Retail Display Area
- Warehouse

SPECIFICATIONS

- INPUT VOLTAGE: 24 VDC (supplied by TRP-D, see below), 24 MA nominal
- WIRING: Class 2, #22 AWG (between sensor and powerpack)
- TEMPERATURE RANGE: 50°F to 104°F (10°C to 40°C)
- SIZE: 4¾" L x 3⅞" W x 1⅝" D.
- WEIGHT: 4.25 oz.
- COLOR: Metal Chromium body, Cover is Ivory.
- MOUNTING: Ceiling

SPECIFICATIONS FOR TRP-D POWERPACKS

- Multi-voltage 100 - 277 VAC 50/60 Hz input voltage
- 150mA, 24 VDC isolated output, short circuit protected
- Can supply power for up to 4 sensors.
- Zero Arc Point Switching
- CONTACT RATINGS: 20A, 120 VAC Incandescent, 20A, 120 or 277 VAC 20A Ballast
- 120 or 277 VAC 1HP Motor Load
- SIZE: 3.69"L x 2.33"W x 1.36"H



TORK TRP-D POWER PACK MUST BE USED IN CONJUNCTION WITH SENSOR.

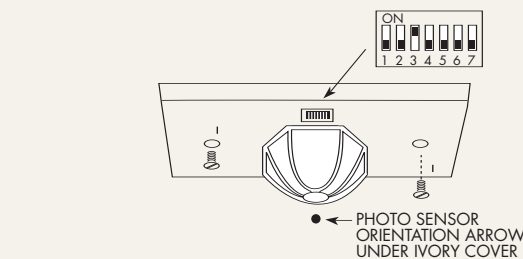

PROGRAMMABLE 7-SECTION SLIDE SWITCH FOOT CANDLE SELECTION.
NOTE: Slide only one switch to ON for selection, all other switches remain off.

SLIDE	FOOT CANDLE	FOR
#1	10FC	Warehouse
#2	25FC	Corridors
#3	50FC	Machine Equipment Display Showroom (such as automobile and farm equipment) LOBBY (such as airport waiting area)
#4	75FC	Classrooms, Common Office Areas
#5	100FC	Drafting Rooms
#6	150FC	Retail Display Areas
#7	250FC	High Critical Areas Product Sorting and Grading Paint Quality Control.

CATALOG NO	UPC CODE	DESCRIPTION
ELS-1	82049	INDOOR DAYLIGHT SENSOR - 24VDC SUPPLIED BY POWERPACK (SEE BELOW)
TRP-D	82301	TRANSFORMER RELAY POWERPACK 100-277VAC

SPECIFICATION WRITER'S GUIDE

Furnish and install where indicated an electronic light sensor capable of turning lighting off at a user defined footcandle level. Sensor shall be equipped with a separate adjustment for delayed turn OFF in 3-15 minutes. Sensor shall be designed for mounting onto a ceiling. Sensor shall have red LED indication when light level is below foot-candle setting. Sensor shall have green LED indication when light level is above foot-candle setting. Sensor shall have 7 slide switches for setting foot-candle level (10, 25, 50, 75, 100, 150 or 250).

Sensor is to be supplied with a transformer relay powerpack which can be installed remote from sensor using low voltage wire. (Powerpack can be installed close to load in order to minimize line voltage wiring.) The remote powerpack shall be capable of installation in a single or multiple gang box. One remote powerpack shall be capable of operating a maximum of one sensor. Sensor and transformer relay powerpack shall be TORK Models ELS-1 and TRP-D respectively, or equal.

TYPICAL WIRING DIAGRAMS

STANDARD LOW VOLTAGE INSTALLATION WITH POWERPACK IN ACCESSIBLE TILE CEILING.

IMPORTANT NOTES:

1 When interrupting the high voltage lighting circuit with a wall switch, it is important not to interrupt the power pack input power (black wire). This will avoid the initial 30 second time delay when the lights are first turned on.

2 Since the Model ELS-1 has a 30 second initial time delay, it is recommended that the on/off switch be put on the low voltage secondary circuit. In other words, it will take 30 seconds before lights are actually switched on after primary power to the power pack is restored.

SPECIAL NOTES:

One TRP-D powerpack can operate one ELS-1 unit. One ELS-1 can be combined with one TORK Model OSCW5P, OSCW15P, OSC5U, OSC10U, OSC20U, or OSC20UP to achieve occupancy and light level control.

Some existing lighting systems are wired directly from Breaker Control Cabinet and have no light switches. For this type of lighting system, it is sometimes more convenient to install the powerpacks close to the circuit Breaker Control Cabinet, allowing for easier circuit identification and easy wiring of low voltage cable to ELS-1 units.

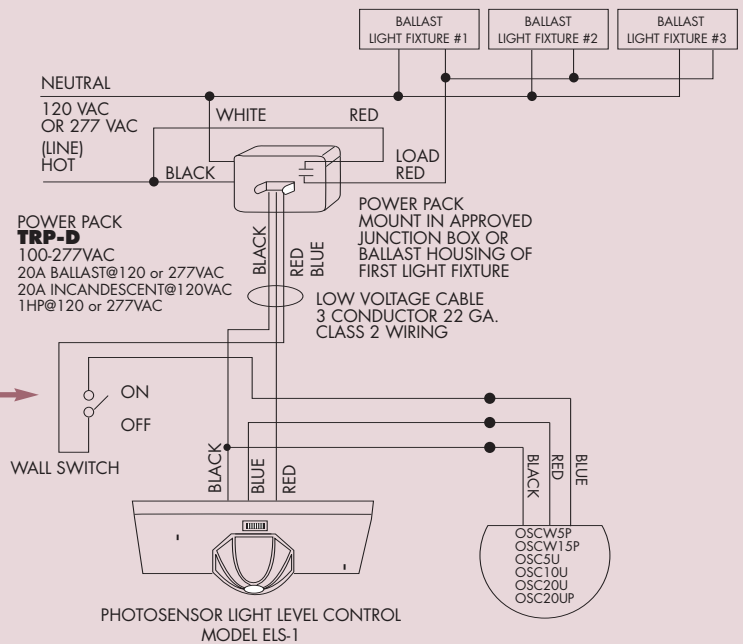
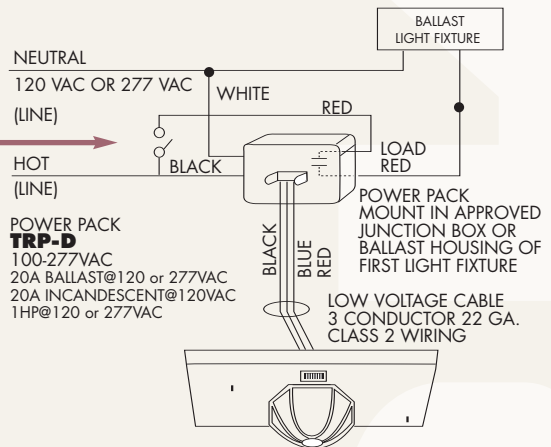

FOR COMBINATION PHOTOCONTROL/TIME OF DAY

MOUNTING

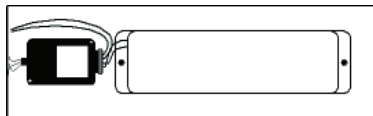

MOUNTS INSIDE FIXTURE BALLAST CAVITY

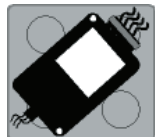

MOUNTS INSIDE STANDARD 4 x 4 JUNCTION BOX

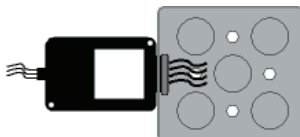

MOUNTS OUTSIDE JUNCTION BOX VIA 1/2" EMT THREADED NIPPLE

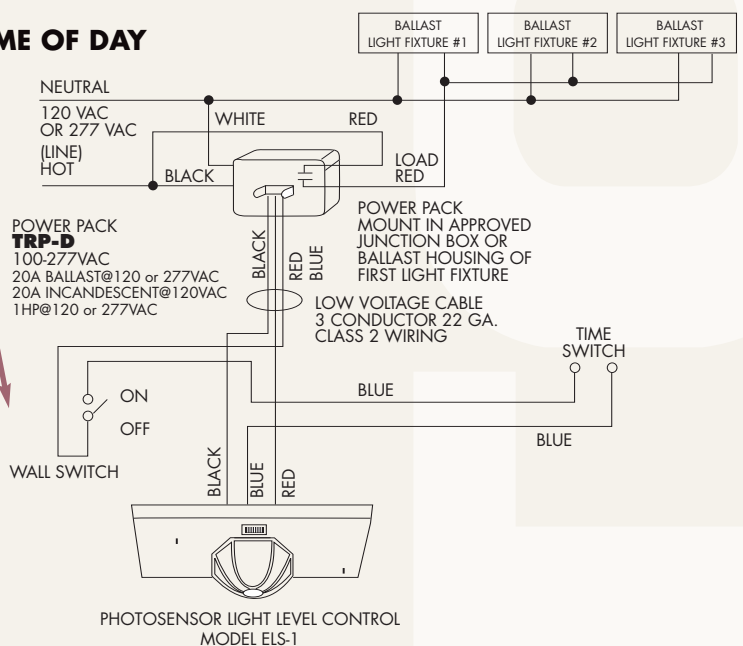

TORK TECHNICAL INFORMATION: 888.500.4598
REQUEST YOUR COMPLETE SET OF TORK CATALOGS TODAY!



NSI INDUSTRIES, LLC • USA • 800-321-5847 • FAX 800-841-5566 • www.nsiindustries.com

TORK®